

GENERAL INFORMATION

Handing Locks (& Doors)

All Keylex lock models are 'field reversible'. Therefore you do not need to specify the hand of the lock when ordering. However, when installing the Keylex 700 on rebated double doors it is necessary to establish the hand of the door in respect of the rebate kit. There are four distinct handing codes describing four possible applications:

LH Left Hand = Clockwise closing door with the digital keypad on the push side.

LHR Left Hand Reverse = Anti-clockwise closing door with the digital keypad on the pull side.

RH Right Hand = Anti-clockwise closing door with the digital keypad on the push side.

RHR Right Hand Reverse = Clockwise closing door with the digital keypad on the pull side.

The hand of the lock is the same as the hand of the door. The hand of the rebate kit is the same as the hand of the lock.

Rebate Kits (all models)

Two part rebate kits are available (stainless steel) in the following sizes to suit all series of Keylex locks; **13mm, 19mm and 25mm**

Extra Thick Doors (all models)

Extra long fixings, spindle extensions and passage turn extensions are available to suit any door thickness.

Blanking Plates (all models)

A blank plate for the passage function facility is available on the all Keylex models as are blanking buttons for the inside lever furniture on Keylex 700, 800 & 500 models only.

Emergency & Panic Exit Devices (K2100 & K700 only)

Conversions are available for all K2100 series and K700 series models allowing operation with rim mounted emergency exit and panic exit devices. Conversions are available for the following manufacturers' devices (rim mounted applications only - including latch and vertical rod designs).
a) Briton b) Dorma c) Von Duprin

Back-to-Back Operation (K2100 & K700 only)

Bi-directional coded access control via the same door is achieved using either the Keylex model K2100 or K700 in a back-to-back application. 'Back-to-back' is not available on Keylex models K800 & K500.

K700B is the factory built solution available ex-stock to suit doors 35mm to 50mm thick.

K700B2 is the factory built solution available ex-stock to suit doors 50mm to 65mm thick.

K2100B is our modification introducing a mounting plate to one side of the door. This solution particularly addresses security requirements at external gates where it may be possible to access the 'secure' side of a gate by reaching through to the other side.

This solution should never be introduced to doors on emergency exit routes.

Spy Shields (all models)

Where security is paramount and the opportunity for unauthorized observation of code entry exists, it is possible to introduce a spy shield to reduce the chance of code entry copying. Available to special order on all models.

Knurled Knob (K2100 only)

The normally smooth knob design on Keylex model K2100 can be modified to introduce a knurled or textured finish. This facilitates extra grip for use by the elderly, infirm or operation by those who may have wet hands. Available to special order.

Rim Mounted Solutions (K2100, K800 & K500 only)

Occasionally, door and frame designs dictate that conventional mortice lock solutions become impractical. Rim mounted solutions exist (for the models detailed above) and are, in the case of K800 & K500, normally available ex-stock.

Because of the nature of their operation certain features such as passage function are unavailable. All rim mounted locks are supplied with knob furniture to both sides of the door.

SPECIFICATION & AVAILABLE FEATURES

		2100	700	800	500
Security Level	High	●	●		
	Medium			●	
	Low				●
Duty Level	Heavy	●			
	Standard		●	●	●
Location	External/Internal	●	●		
	Internal Only			●	●
Application	Mortice	●	●	●	●
	Rim	●		●	●
	Back-To-Back	●	●		
Furniture	Knob	●	●	●	●
	Lever	●	●	●	●
	Knob/Lever	●			
Lock Case 60mm	Sash Lock		●		
Backset	50mm				
	* (60 and 70mm - model 500)	●		●	●
	76mm	●			
Euro Profile Cylinder	Not Required			●	
	63mm Double			●	
Escutcheon Plates	Blank			●	
	70-72mm			●	
	90-92mm			●	
Key Override	To Differ	●	●	●	
	Keyed Alike	●	●	●	
	Master Keyed	●	●	●	
Door Thickness	45mm				●
	50mm		●	●	
	58mm		●	●	
	75mm		●	●	●
Finish	Satin Chrome SC	●	●	●	●
	Antique Brass AB	●			
	Dark Bronze DB		●	●	●
Rebate Kit 13/19/25mm (Please Specify)	Reversible	●	●	●	●
	LH/RHR		●		
	RH/LHR		●		
Exit Device Modification	Von Duprin 22	●	●		
	Von Duprin 99	●	●		
	Briton	●	●		
	Dorma	●	●		
Passage Snib Modification	Standard	●	●	●	●
	Blank Plate	●	●	●	●
	Removable Key	●	●	●	●
Spy Proof Housing	Aluminium	●	●	●	●
	Stainless Steel	●	●	●	●

Key: ● Default You will receive this option unless you specify otherwise
● Optional Specify at order placement
● Only An inherent feature

SECURIKEY®

KEYLEX 2100 HEAVY DUTY
KEYLEX 700 STANDARD DUTY
KEYLEX 800 CLASSIC
KEYLEX 500 MINI

KEYLEX MECHANICAL DIGITAL LOCKS

Providing security & access control in the most demanding situations

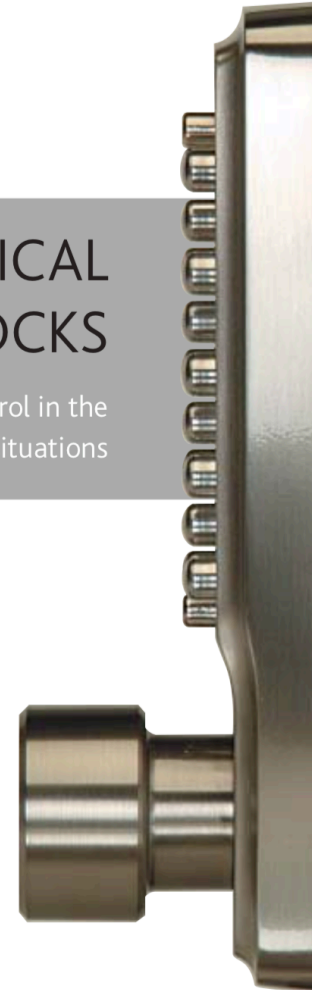

Securikey Limited, PO BOX 18, Aldershot, Hampshire, GU12 4SL

Telephone: +44 (0)1252 311888

Facsimile: +44 (0)1252 343950

Web: www.securikey.co.uk

Email: enquiries@securikey.co.uk

SECURIKEY®

INTRODUCTION TO THE RANGE

In almost all security and access control situations, it is a requirement of authorised users that they have the facility to open the door from a point close at hand. The Keylex range of products addresses this requirement as they operate without wiring or battery power.

Because Keylex locks are so simple to operate, they are ideal for use in small, budget systems. Keylex locks are designed for doors where authorised users are issued with a common code and for doors that do not need to be controlled electronically.

The Keylex range of locks has been part of the Securikey product portfolio for many years. During this time we have developed and improved the range to include mechanical digital technology offering reliable security at 4 different levels.

We are continually improving designs and have recently introduced the 'clutch' mechanism (an important feature of the established Keylex 2100 range) to the 700 series, ensuring greater protection against vandalism and misuse.

Certain Keylex models can be adapted for use with panic and emergency escape hardware from a number of manufacturers. This has been an important growth area for Securikey over recent years and we will consider adaptations for any device.

In summary, we believe simple mechanical digital control has an important role to play in the access control market place and that the Keylex lock is the definitive solution for most applications.

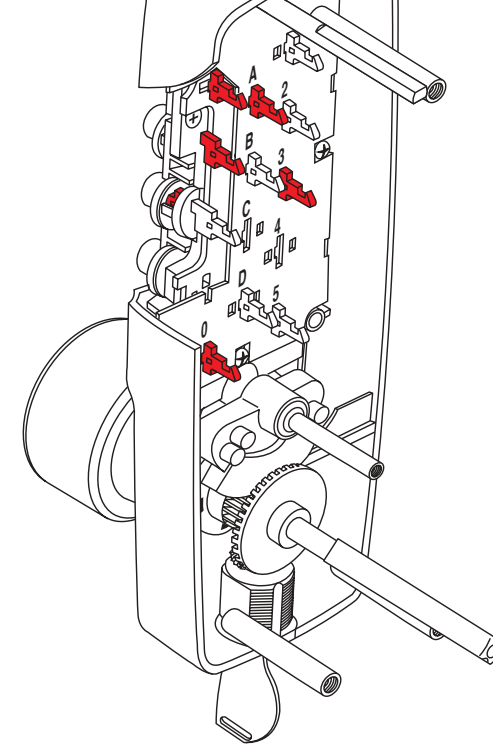

SPECIFICATION GUIDANCE

Different security levels are achieved via a combination of the latch and/or lock case, the choice of code (i.e. the number of digits in the code) and the number of available code options. Hence, Keylex 2100 with 14 push buttons offering over 16,000 possible combinations, coupled with an auto double throw dead latch, offers superior security for 'external door' and 'main entrance' applications.

Keylex models 700, 800 and 500 each have 12 push buttons and offer 4000 available combinations but the variance in their suitability for differing applications is a function of the latch and lock case choice along with certain other available features.

TECHNICAL & SPECIFICATION SERVICES

Modified solutions for unusual applications such as extra thick doors, back-to-back models (2100 & 700 only) and master keyed key override systems are available to special order.

APPLICATIONS

Keyless access has many advantages. The simple entry of the correct code at the keypad unlocks the door and, because there are no keys to be stolen or lost, security is not at risk and the expense of producing and accounting for large numbers of keys is saved.

Keylex locks can be used on any door where access control is a requirement. Correct lock specification is determined, in the main, by the desired level of security. This flexible range of locks offers security at four distinct levels.

- 2100** High Security/Heavy Duty
- 700** High Security/Standard Duty
- 800** Medium Security/Standard Duty
- 500** Low Security/Standard Duty

2100 - is best suited to external doors requiring a heavy-duty solution where final security is a requirement. The robust proven design offers the user up to 16,000 possible combination settings for additional peace of mind.

700 - also suited to external doors and gives flexibility offered by the inclusion of a mortice sash lock. This model is particularly suited to narrow stile applications and high security standard duty situations where Euro Profile key override is an additional requirement.

800 - best suited to standard duty situations on internal doors where a reasonable level of security is a requirement with optional key override.

500 - suitable for light to standard duty situations on internal doors where access control is a requirement but at a reduced level of security.

KEYLEX 2100

Use the Keylex 2100 on all external door installations and on any door where heavy traffic or extreme use and abuse can be expected. The proven design, with its built-in slipping clutch mechanism, will withstand all but the most violent attacks and can be expected to give many years service if specified and maintained correctly.

STANDARD FEATURES & BENEFITS

High quality mortice deadlocking latch

Solid bolt ensures secure re-locking every time.

Anti-thrust snib on double-throw latch

Prevents latch from being prised back.

Heavy duty mechanism

Allows many hundreds of operations per day.

Entirely mechanical operation

No electronics or electrical wiring involved.

Allows code combinations of up to 14 buttons

Over 16,000 selectable code permutations (recommended 3 to 6 digit codes).

Code scramble

Allows all codes to be entered in any order.

Slipping clutch mechanism

Nullifies forced attack or vandalism from the outside.

Passage function

Allows free passage from both sides at code users' discretion.

Brushed stainless steel buttons

Will not indicate useage.

Free exit

Provides escape from the inside, without code entry, regardless of the lock status.



SC



AB

Mortice deadlocking latch.
76mm backset, 60mm (optional).

OPTIONAL FEATURES & BENEFITS

Key override

Allows key holder access in all instances without prior knowledge of the code.

Keyed alike

Allows single key override to multiple locks.

Rebate kits

13mm, 19mm and 25mm two part rebate kits are available - Allows installation on double door applications.

Suitability

External Doors • Internal Doors • Timber • Aluminium • Steel

Door thickness

28mm to 58mm standard

Up to 75mm optional.

Stile width

76mm Backset Latch - Minimum 114mm

60mm Backset Latch - Minimum 98mm.

Lock furniture

The default Keylex 2100 is supplied with knob furniture to both sides of the door. Optionally, lever or split design furniture, i.e. knob outside/lever inside is available but must be specified at order placement also.

Backset length

The default backset length for the mortice deadlocking latch is 76mm.

An optional 60mm backset is available and must be specified at order placement.

Finishes/Materials

Lock body construction is zinc & solid brass. All code buttons are stainless steel.

The standard finish is Satin Chrome (Silver). An optional Antique Brass finish is available to special order.

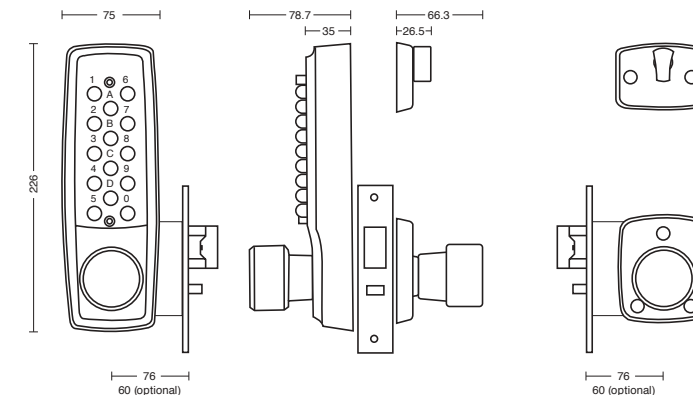

LOCK OPERATION & FUNCTION DESCRIPTION - K2100

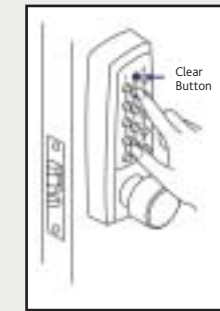

Clearing Codes

It is essential that any 'spurious' code be cleared before operation of the lock from the outside. The clear button should be pressed before your code.

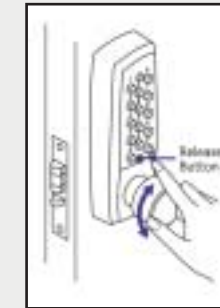

Entering Codes

Codes should be ideally selected to contain between 3 and 6 digits and can include a mixture of letters and numerals. Buttons may be pressed in any order and must be pushed firmly to engage the code. Once the correct code is entered, followed by the release button, the lock may be used. If mistakes are made you may clear the code using the procedure described above.

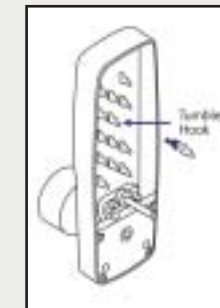

Changing Codes

Code changing is fast and straightforward, requiring a screwdriver and a little dexterity. Codes are set via a series of hooks and their relative orientation.

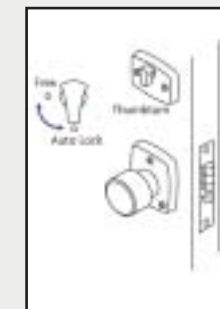

Setting the Passage Function

Keylex locks do not include a 'hold-back' facility. However, the passage function facility achieves the same end result. The door is opened using the correct code and (while the door is ajar) the passage function snib is set to 'free passage'. The lock is then free from either side until such time as the passage function snib is re-set.

NOTE - only authorised code holders can set the passage function feature. It is possible to modify the feature to include a removable key to restrict the feature to 'key holders' only.

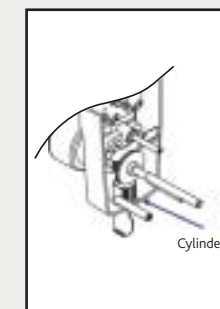

(Optional) Key Override

The key override cylinder is hidden at the base of the lock body and provides an override to the code for any key holder. This facility is convenient to building owners or premises managers who may have a number of locks, each with different user codes, to manage.

Key override locks can be provided with cylinders keyed alike, to differ or under a mastered suite. Each cylinder is supplied with a minimum of two keys.

KEYLEX 700

Use the Keylex 700 on all standard duty, high security external door installations and on any door where a flexible euro profile keying system is required.

The 'narrow stile' design, with its built-in slipping clutch mechanism, will suit all stile widths down to 43mm and is particularly suited for use with aluminium or hollow metal sections.

STANDARD FEATURES & BENEFITS

Suits most sash locks with 70-72mm centres or 90-92mm centres with any backset length - Users can specify their own lock case or utilise existing lock cases on retrofit installations.

Standard duty mechanism

Allows many hundreds of operations per day.

Entirely mechanical operation

No electronics or electrical wiring involved.

Allows code combinations of up to 12 buttons

Over 4,000 selectable code permutations (recommended 3 to 6 digit codes).

Code scramble

Allows all codes to be entered in any order.

Brushed stainless steel buttons

Will not indicate usage.

Override code holder

The code holder can be prevented entry by the keyholder throwing the mortice bolt on the lock case.



Mortice sash lock, 60mm backset, 70-72mm centres.



SC

DB

OPTIONAL FEATURES & BENEFITS

Key override. Euro profile escutcheons

Allow key holder access (single or double cylinder) in all instances without prior knowledge of the code. Blank escutcheons are available as required.

Keyed alike

Allows single key override to multiple locks.

Passage function

Allows free passage from both sides at code users' discretion (optional).

Rebate kits

13mm, 19mm and 25mm two part 'handed' rebate kits are available - Allows installation on double door applications.

Slipping clutch mechanism

Nullifies forced attack or vandalism from the outside.

Suitability

External Doors (Particularly narrow stile doors) • Internal Doors • Timber • Aluminium • Steel

Door thickness

30mm to 50mm standard
Up to 75mm optional.

Stile width

50mm Backset Latch - Minimum 70mm
23mm Backset Latch - Minimum 43mm.

Lock furniture

The default Keylex 700 is supplied with lever furniture to both sides of the door. Optionally, knob furniture design is available (ex-factory) but must be specified at order placement. Knob furniture may be suitable for heavier doors or doors where vandalism is anticipated. Consider upgrading the specification to Keylex 2100.

Backset length

Backset length is dictated by the choice of lock case. Lock cases are not normally supplied with the Keylex 700, unless specifically ordered. The default lock case is supplied with a 60mm backset.

Finishes/Materials

Lock body construction is cast zinc. All code buttons are stainless steel. The standard finish is SC (Silver). An optional DB (Dark Bronze) finish is available from stock.

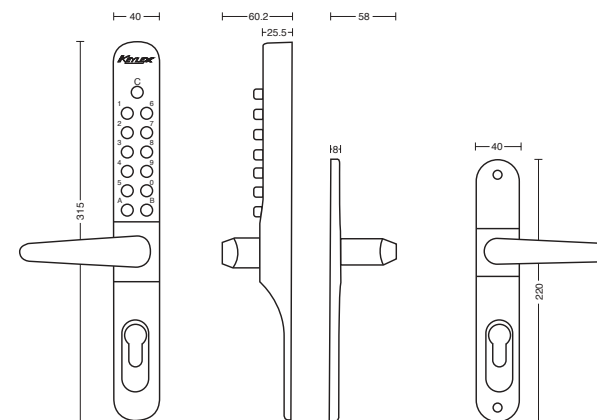

LOCK OPERATION & FUNCTION DESCRIPTION - K700

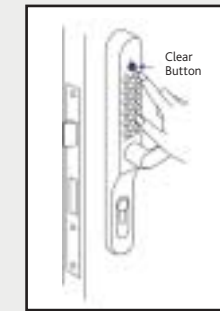

Clearing Codes

It is essential that any 'spurious' code be cleared before operation of the lock from the outside. The clear button should be pressed before your code.

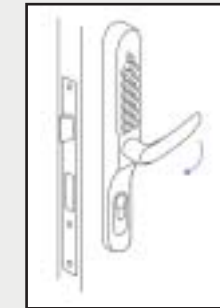

Entering Codes

Codes should be ideally selected to contain between 3 and 6 digits and can include a mixture of letters and numerals. Buttons may be pressed in any order and must be pushed firmly to engage the code. Once the correct code is entered the lock may be used. If mistakes are made you may clear the code using the procedure described above.

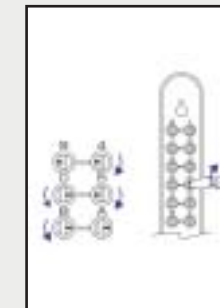

Changing Codes

Code changing is fast and straightforward requiring only a slotted screwdriver once the lock body is removed from the door. Each button is marked with a single line at right angles to the screwdriver slot with corresponding marks adjacent on the back plate. Rotate the button to align the two marks thus setting that button as part of the code.



Setting the (Optional) Passage Function

Keylex locks do not include a 'hold-back' facility. However, the passage function facility achieves the same end result (passage function must be specified as an optional extra with the Keylex 700). The door is opened using the correct code and (while the door is ajar) the passage function snib is set to 'free passage'. The lock is then free from either side until such time as the passage function snib is re-set.

NOTE - only authorised code holders can set the passage function feature. It is possible to modify the feature to include a removable key to restrict the feature to 'key holders' only.

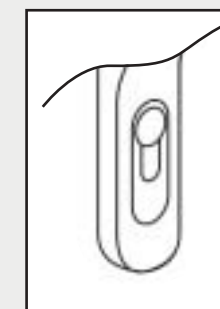

Key Override

The key override euro profile cylinder is located at the base of the lock body and provides an override to the code for any key holder. This facility is convenient to building owners or premises managers who may have a number of locks, each with different user codes, to manage. Cylinders are not normally supplied with the Keylex 700, unless specifically ordered. The default cylinder is a 63mm double cylinder SN (Satin Nickel). Cylinders can be provided keyed alike, to differ or under a mastered suite. Each cylinder is supplied with a minimum of two keys.

KEYLEX 800

Use the Keylex 800 on all standard duty, medium security internal door installations. The 'narrow stile' design will suit all stile widths down to 80mm and is particularly suited for use with aluminium or hollow metal sections.



Mortice deadlocking latch. 60mm backset.

STANDARD FEATURES & BENEFITS

High quality mortice deadlocking latch - Solid bolt ensures secure re-locking every time.

Anti-thrust snib on double-throw latch
Prevents latch from being prised back.

Standard duty mechanism
Allows many hundreds of operations per day.

Entirely mechanical operation
No electronics or electrical wiring involved.

Allows code combinations of up to 12 buttons
Over 4,000 selectable code permutations (recommended 3 to 6 digit codes).

Code scramble
Allows all codes to be entered in any order.

Passage function
Allows free passage from both sides at code users' discretion.

Brushed stainless steel buttons
Will not indicate usage.

Free exit
Provides escape from the inside, without code entry, regardless of the lock status.



SC

DB

OPTIONAL FEATURES & BENEFITS

Key override
Allows key holder access in all instances without prior knowledge of the code.

Keyed alike
Allows single key override to multiple locks.

Rebate kits
13mm, 19mm and 25mm two part rebate kits are available - Allows installation on double door applications.

Suitability
Internal Doors • Timber • Aluminium • Steel

Door thickness
30mm to 45mm standard
Up to 75mm optional.

Stile width
60mm Backset Latch - Minimum 80mm.

Lock furniture
The default Keylex 800 is supplied with lever furniture to both sides of the door. Optionally, knob furniture design is available (ex-factory) but must be specified at order placement. Knob furniture may be suitable for heavier doors or doors where vandalism is anticipated. Consider upgrading the specification to Keylex 700 with slipping clutch mechanism.

Backset length
The default backset length for the mortice deadlocking latch is 60mm.

Finishes/Materials
Lock body construction is cast zinc. All code buttons are stainless steel. The standard finish is SC (Silver). An optional DB (Dark Bronze) finish is available from stock.

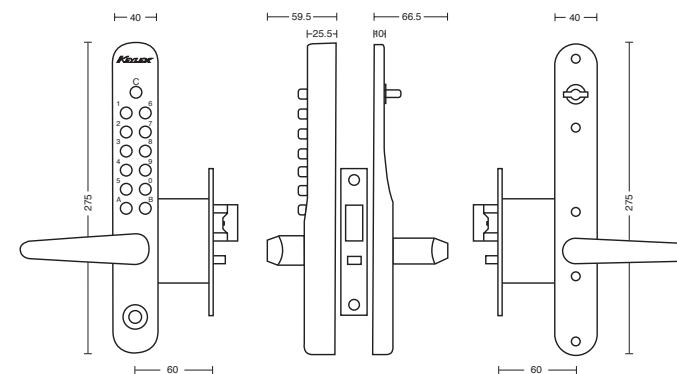

LOCK OPERATION & FUNCTION DESCRIPTION - K800

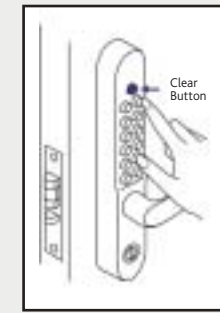

Clearing Codes
It is essential that any 'spurious' code be cleared before operation of the lock from the outside. The clear button should be pressed before your code.



Entering Codes
Codes should be ideally selected to contain between 3 and 6 digits and can include a mixture of letters and numerals. Buttons may be pressed in any order and must be pushed firmly to engage the code. Once the correct code is entered the lock may be used. If mistakes are made you may clear the code using the procedure described above.

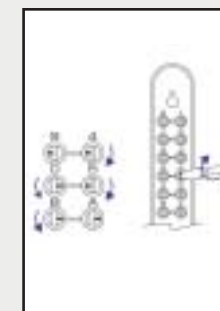

Changing Codes
Code changing is fast and straightforward requiring only a slotted screwdriver once the lock body is removed from the door. Each button is marked with a single line at right angles to the screwdriver slot with corresponding marks adjacent on the back plate. Rotate the button to align the two marks thus setting that button as part of the code.

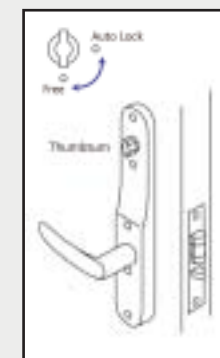

Setting the Passage Function
Keylex locks do not include a 'hold-back' facility. However, the passage function facility achieves the same end result. The door is opened using the correct code and (while the door is ajar) the passage function snib is set to 'free passage'. The lock is then free from either side until such time as the passage function snib is re-set.

NOTE - only authorised code holders can set the passage function feature. It is possible to modify the feature to include a removable key to restrict the feature to 'key holders' only.



(Optional) Key Override
The key override cylinder is located at the base of the lock body and provides an override to the code for any key holder. This facility is convenient to building owners or premises managers who may have a number of locks, each with different user codes, to manage.

Cylinders can be provided keyed alike, to differ or under a mastered suite. Each cylinder is supplied with a minimum of two keys.

KEYLEX 500 (MINI)

Use the Keylex 500 on all standard duty, low security internal door installations. The 'narrow stile' design will suit all stile widths down to 80mm and is particularly suited for use with timber doors.



Tubular deadlocking latch, 60mm & 70mm backset combined.



STANDARD FEATURES & BENEFITS

- High quality tubular deadlocking latch**
Ensures secure re-locking every time.
- Anti-thrust snib on latch**
Prevents latch from being prised back.
- Standard duty mechanism**
Allows many hundreds of operations per day.
- Entirely mechanical operation**
No electronics or electrical wiring involved.
- Allows code combinations of up to 12 buttons**
Over 4,000 selectable code permutations (recommended 3 to 6 digit codes).
- Code scramble**
Allows all codes to be entered in any order.
- Passage function**
Allows free passage from both sides at code users' discretion.
- Brushed stainless steel buttons**
Will not indicate usage.
- Free exit**
Provides escape from the inside, without code entry, regardless of the lock status.

OPTIONAL FEATURES & BENEFITS

- Rebate kits**
13mm, 19mm and 25mm two part rebate kits are available - Allows installation on double door applications.
- Suitability**
Internal Doors • Timber • Aluminium • Steel
- Door thickness**
30mm to 45mm standard
Up to 75mm optional.
- Stile width**
60mm Backset Latch - Minimum 80mm
70mm Backset Latch - Minimum 90mm.
- Lock furniture**
The default Keylex 500 is supplied with lever furniture to both sides of the door. Optionally, knob furniture design is available (ex-factory) but must be specified at order placement. Knob furniture may be suitable for heavier doors or doors where vandalism is anticipated. Consider upgrading the specification to Keylex 700 with slipping clutch mechanism.
- Backset length**
The default backset length for the tubular deadlocking latch is 60mm & 70mm combined in one unit.
- Finishes/Materials**
Lock body construction is cast zinc. All code buttons are stainless steel. The standard finish is SC (Silver). An optional DB (Dark Bronze) finish is available from stock.

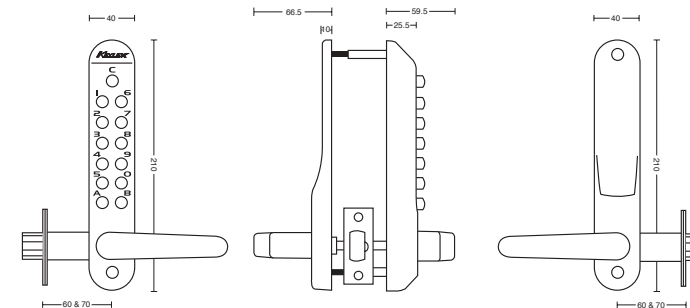

LOCK OPERATION & FUNCTION DESCRIPTION - K500 (MINI)

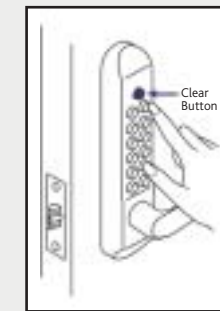

Clearing Codes
It is essential that any 'spurious' code be cleared before operation of the lock from the outside. The clear button should be pressed before your code.

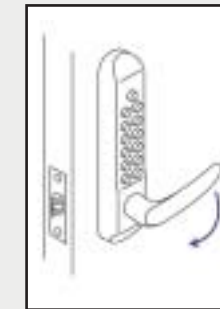

Entering Codes
Codes should be ideally selected to contain between 3 and 6 digits and can include a mixture of letters and numerals. Buttons may be pressed in any order and must be pushed firmly to engage the code. Once the correct code is entered the lock may be used. If mistakes are made you may clear the code using the procedure described above.

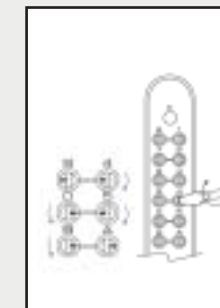

Changing Codes
Code changing is fast and straightforward requiring only a slotted screwdriver once the lock body is removed from the door. Each button is marked with a single line at right angles to the screwdriver slot with corresponding marks adjacent on the back plate. Rotate the button to align the two marks thus setting that button as part of the code.



Setting the Passage Function
Keylex locks do not include a 'hold-back' facility. However, the passage function facility achieves the same end result. The door is opened using the correct code and (while the door is ajar) the passage function snib is set to 'free passage'. The lock is then free from either side until such time as the passage function snib is re-set.

NOTE - only authorised code holders can set the passage function feature. It is possible to modify the feature to include a removable key to restrict the feature to 'key holders' only.